

GLOW STUNT DRONE

GLOW STUNT DRONE

AGES  
14+

## 用户手册

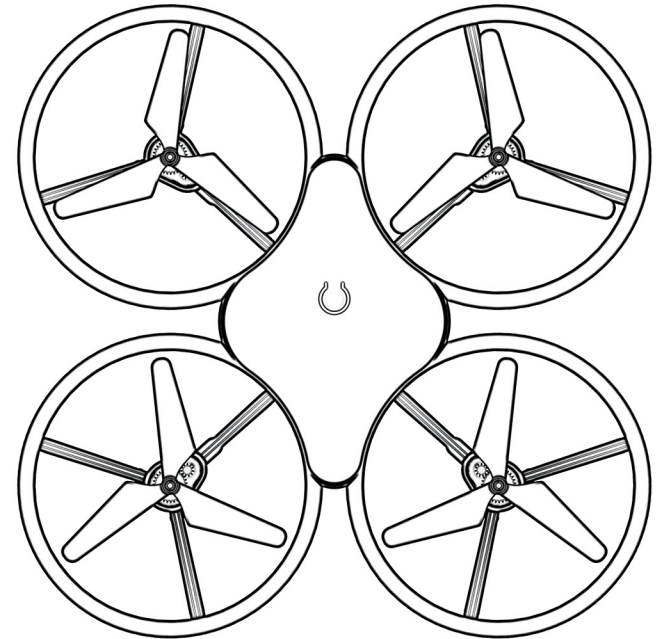

BEFORE USE, READ ALL WARNINGS AND  
INSTRUCTIONS IN THIS MANUAL.

---

**T20 DRONE**

## 目录

安全警告

配件清单

电池安装和电池充电

更换桨叶

遥控器概览

操作无人机

操作

灯光切换功能

其它功能

第 2 页

第 3 页

第 4&5 页

第 6 页

第 7 页

第 8 页

第 9 页

第 10 页

第 11 页

## 安全警告

- 不建议 14 岁以下儿童使用。与所有电器产品一样，在处理和使用过程中应遵守预防措施，以减少触电的风险。
- 任何时候都需要成人监督。
- 切勿在人的上方或附近飞行无人机，风或其他条件的突然变化可能导致意外。
- 飞行无人机时务必谨慎，遵守相关法律，尊重隐私和他人的财产权。
- 不得对无人机进行改装或用于其预期用途以外的任何用途。
- 每次使用前，应检查产品和电池以确定没有损坏或存在危险。
- 不要接触旋转的螺旋桨。
- 操作无人机时要小心并注意周围环境。
- 请勿将无人机飞向动物、人或无生命物体。
- 让无人机远离电线、建筑物、树木、公共区域和任何其他潜在危险区域。
- 请勿在雨天、大风或蚂蚁类恶劣天气下操作。
- 不要将无人机降落在潮湿的表面上。
- 飞行中切勿触摸或允许他人触摸无人机。
- 不使用时请务必关闭无人机。
- 始终在大片空地飞行无人机。

丢失是玩家的责任并且  
不会被制造商更换。

## 配件清单

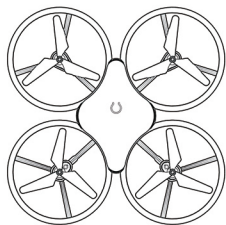

发光特技无人机



遥控器

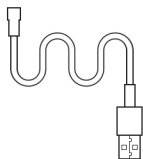

USB 充电线

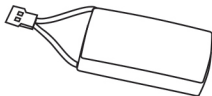

锂电池

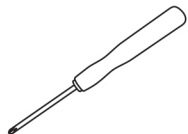

十字螺丝刀



备用螺旋桨

3

## 电池安装和电池充电

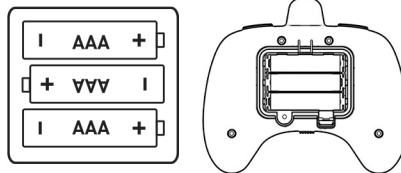

1. 打开电池仓盖。
2. 安装3节“AAA”电池，如上图。
3. 关闭电池仓

### ⚠ 电池警告 - 锂 - 聚合物:

- 如果 Li-Po 电池被刺破、损坏或误用，存在火灾和人身伤害的风险。
- 切勿将电池暴露在极端温度或潮湿环境中。
  - 不要让电池受到强烈撞击。
  - 始终让电池远离易燃材料。
  - 仅使用制造商指定的电池、充电器和/或适配器（如果适用），由制造商指定。
  - 电池无法维修。
  - 充电前让电池冷却至室温。
  - 充电时，切勿让电池无人看管。
  - 根据联邦、州和当地法律回收或处置电池。
- 保留此包装以供参考，因为它包含重要信息。

### 电池警告:

- 不要将新旧电池混用。
  - 请勿混用碱性电池、标准（碳锌）电池或充电电池。
  - 以正确的极性插入电池。请勿将电源端子短路。
  - 不使用时取出电池。根据以下规定回收或处理废旧电池联邦、州和地方法律。请勿将电池丢入火中 - 它们可能会泄漏或爆炸。
  - 仅使用制造商指定的电池、充电器和/或适配器（如果适用），由制造商指定。
  - 始终在成人监督下使用、更换和充电（如果适用）电池。
- 保留此包装以供参考，因为它包含重要信息。

## 电池充电

1. 充电前请关闭无人机。
2. 取下无人机电池并将电池充电线连接到电池上的充电端口
3. 将 USB 连接器连接到电源。

注意：电池充电器在给电池充电时会亮起并在电池充满电后灯灭。

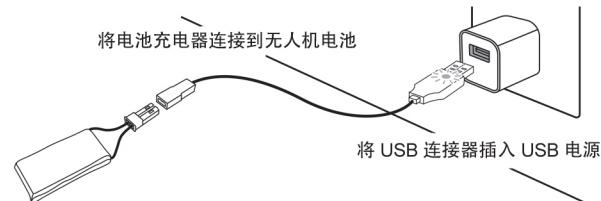

4

### 怎样安装电池

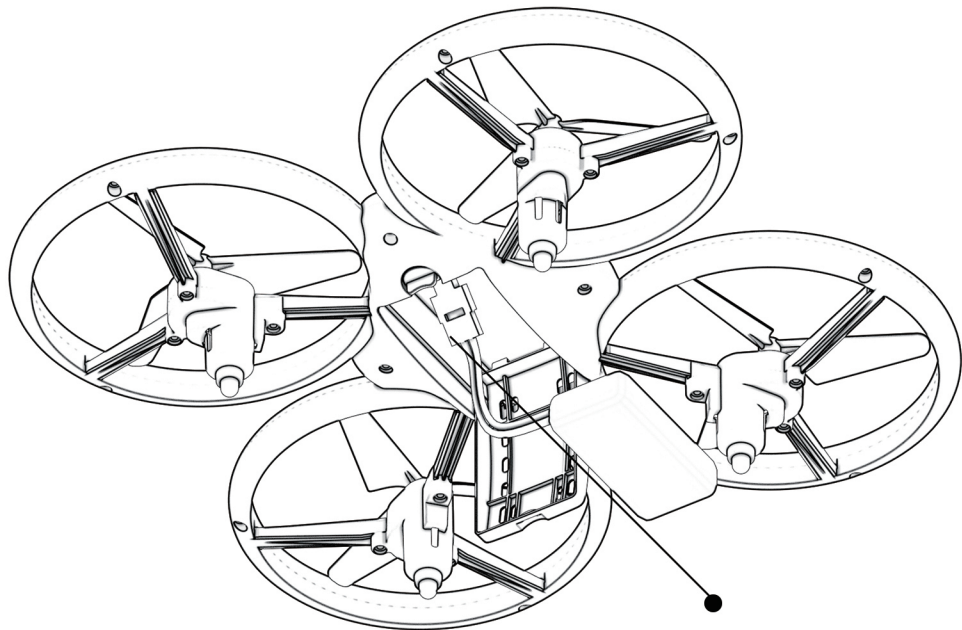

转开底部电池仓，将电池上的插口对准接口，接上电池，切记不要插反。将电池放入电池仓内并盖上电池盖，转紧旋钮，观察电池仓是否紧密扣上。

5

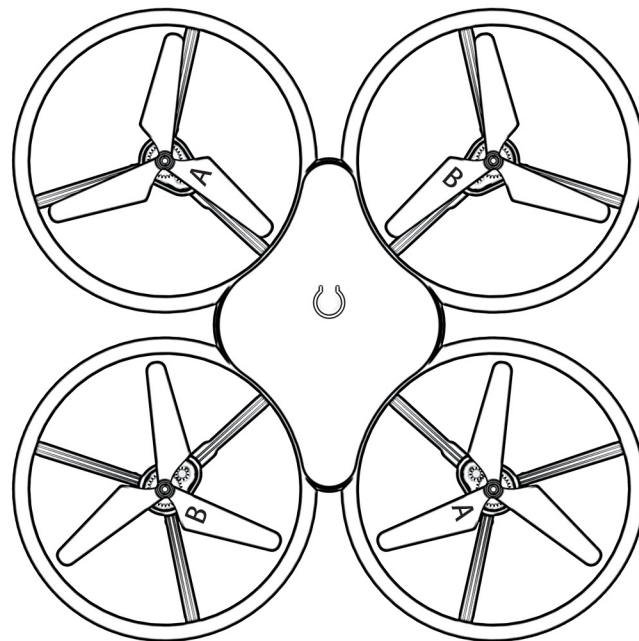

- 只能由成年人更换桨叶。要卸下，请松开螺丝再拉起桨叶。
- 按照图示更换螺旋桨。
- 每个桨叶的旋转方式不同。桨叶 B 逆时针旋转，桨叶 A 顺时针旋转。

6

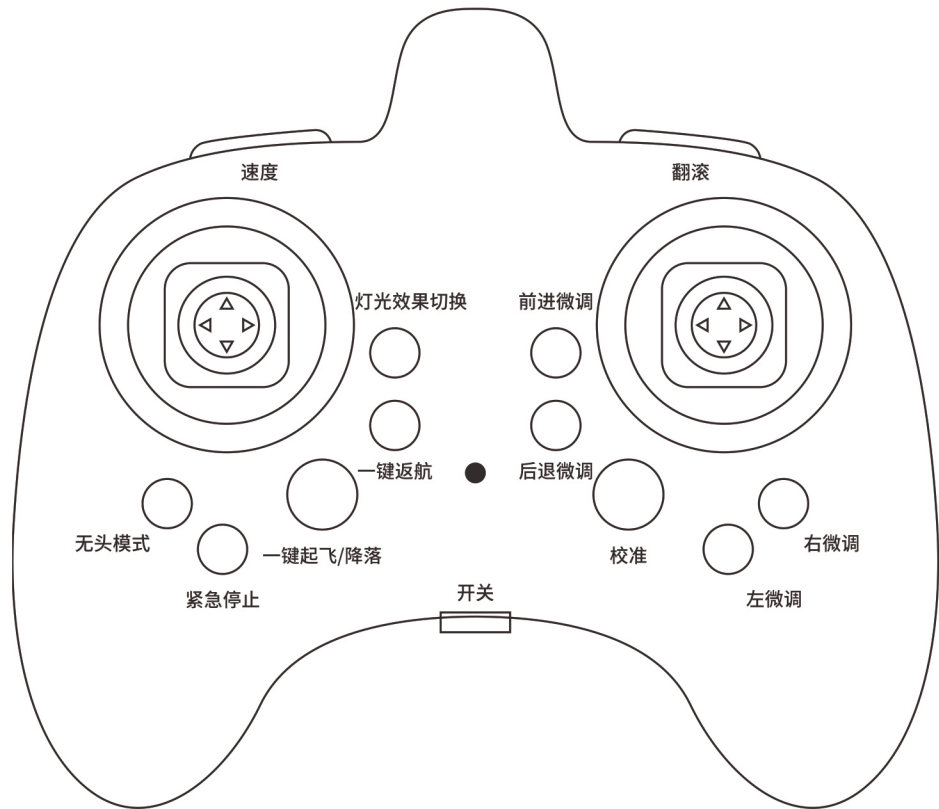

## 第 1 步 - 飞行前检查清单。

1. 阅读所有警告和说明。
2. 安装遥控电池，第 5 页。
3. 给电池充电，第 4 页。
4. 确保无人机和遥控器断电。

## 第 2 步 - 选择位置。

- 无人机设计用于室内和室外飞行。
- 始终确保您有足够的空间来驾驶无人机。
- 始终遵循警告，第 2 页。

## 第 3 步 - 飞行前

- 确保您的遥控器已关闭。
- 按下无人机顶部的电源按钮并按住 1-2 秒，直到 LED 灯亮起。
- 将无人机放置在平坦的表面上。黑色桨叶的那一边应朝向您。
- 打开遥控器。向上然后向下推左摇杆。
- 配对过程中，无人机的灯会闪烁，配对后灯会一直亮着。
- 配对后，遥控器按下校准键进行校准，无人机的灯会闪烁。

## 第 4 步 - 一键起飞

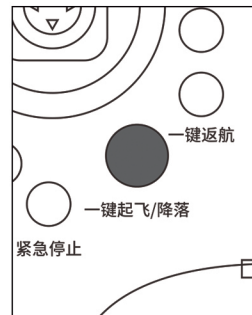

按下一键起飞按钮。

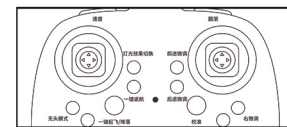
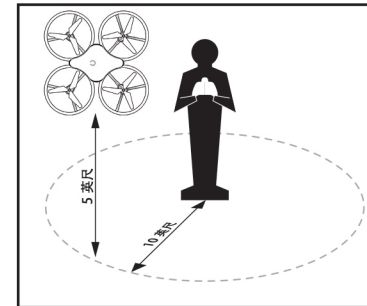

或

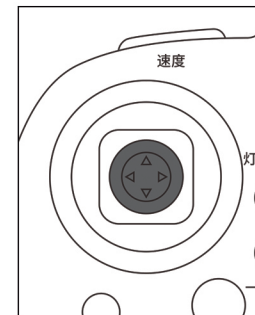

缓慢而小心地推动油门杆。无人机将开始飞行。

## 第 5 步 - 在飞行中操作无人机。

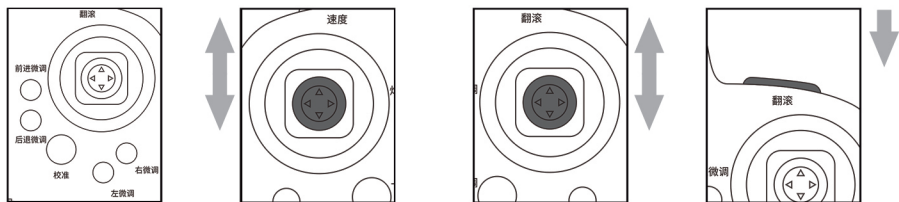

1. 如果您的无人机在起定高过程中发现偏移，请按照此步骤操作。

2. 使用油门操纵杆增加或减少您的高度。

3. 使用多向操纵杆向前、向后或左右移动。

4. 翻滚 - 按下特技按钮，然后按您想要完成翻滚的方向按下多向操纵杆。

- A. 无人机向后漂移：按下向前微调按钮。
- B. 无人机向前漂移：按下向后微调按钮。
- C. 无人机向右漂移：按下向左微调按钮。
- D. 无人机向左漂移：按下向右微调按钮。

注意：  
1. 如果无人机电池电量低，翻滚功能被禁用。  
2. 在尝试翻滚之前将无人机悬停在 10 英尺或以上。

## 第 6 步 - 无人机一键降落

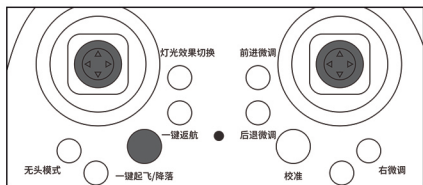

1. 将无人机降低至 20 英尺或更小，然后按下一键降落按钮。使用多向操纵杆操纵无人机。或者将左摇杆向下推，直到无人机着陆。

## 第 7 步 - 检查无人机

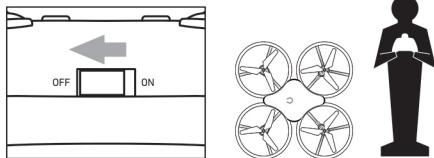

关闭无人机与遥控器

## 灯光切换

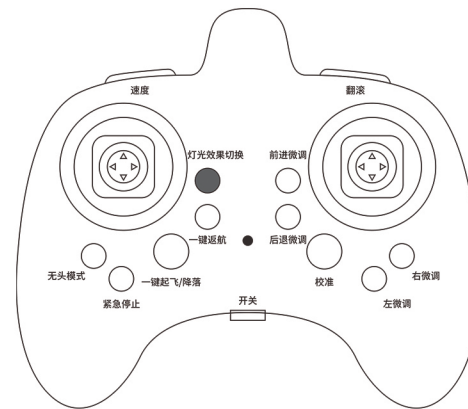

完成对频后可进入灯光切换模式，按下灯光效果切换键即可更改各种五颜六色的炫彩灯光；



## 无头模式/一键返航功能

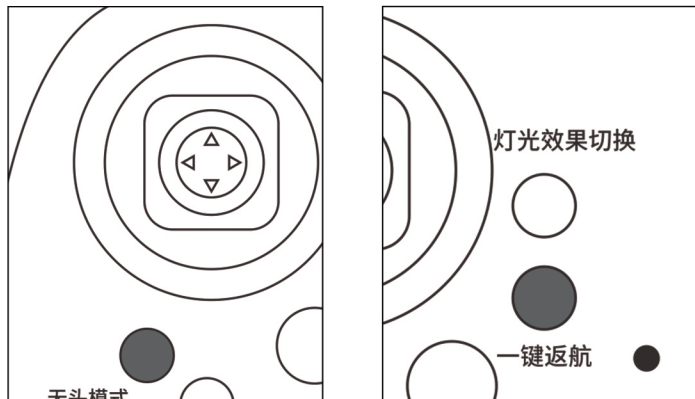

按 无头模式按钮打开模式，然后再按一次关闭无头模式。

● 在此模式下，无人机将始终按照您按下多向键的方向移动。无论无人机面向哪个方向，无人机都会定向到用户（遥控器）。

● 处于无头模式时，遥控器每 6 秒会发出哔哔声。  
当发现紧急情况下按下紧急停止按钮。

**自动返航功能：**  
如需令飞行器自动飞回，请先操控飞行器到操作者前方，按一下返航按钮，飞行器将自动飞回。

### 提示

- 请勿将无人机撞到沙子或泥土中。无人机齿轮可能会堵塞。
- 第一次学习飞行时，练习起飞和悬停。
- 与墙壁和建筑物保持几英尺远。

## Table of Contents

General Warnings	Page 13
Spare Parts List	Page 14
Battery installation and Charging Battery	Page 15~16
Replacing Propellers	Page 17
Remote Overview	Page 18
Operating Drone	Page 19
Operation	Page 20
Light Switching Function	Page 21
Other Features	Page 22

## SAFETY WARNINGS

- Not recommended for children under 14 years of age. As with all electrical products, precautions should be observed during handling and use to reduce the risk of electrical shock.
- Adult supervision is required at all times.
- Never fly drones above or near people, sudden changes in wind or other conditions could lead to unexpected crashes.
- Always use caution when flying drone vehicles, obey relevant laws, respect the privacy and property rights of others.
- The drone shall never be modified or used for anything except its intended purpose.
- Before each use, an adult should review the product and battery to determine that no damage or hazards exist.
- **DO NOT TOUCH SPINNING PROPELLERS.**
- Use caution and pay attention to your surroundings while operating drone.
- Do not fly drone into animals, people, or inanimate objects.
- Keep drone away from power lines, buildings, trees, public areas, and any other potentially hazardous areas.
- Do not operate in rain, heavy wind, and or any type of severe weather.
- Do not land drone on wet surfaces.
- Never touch or allow others to touch drone while it is flying.
- Always turn drone off when it is not in use.
- Always fly drone in large open areas.

Fly-always are the responsibility of the individual pilot and will not be replaced by the manufacturer.

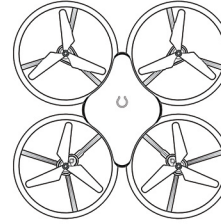

Glow Stunt Drone



Controller

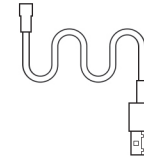

USB Charger Cable

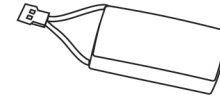

Lithium Battery

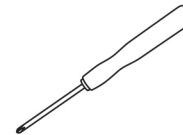

Screwdriver



Replacement Propellers



# BATTERY INSTALLATION AND CHARGING

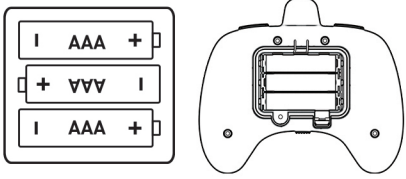

1. Slide open the remote's battery compartment.
2. Install 3 "AAA" batteries as shown in the diagram above.
3. Close battery compartment

## **⚠ BATTERY WARNING - LITHIUM - POLYMER:**

There is a risk of fire and personal injury if Li-Po battery is punctured, damaged or misused.

- Never expose battery to extreme temperatures or moisture.
- Do not subject battery to strong impacts.
- Always keep battery away from flammable materials.
- Only use manufacture specified battery(ies), charger(s) and/or adapter, if applicable, specified by the manufacturer.
- Battery is not serviceable.
- Let battery cool to room temperature before charging.
- While charging, never leave battery unattended.
- Recycle or dispose of battery according to federal, state and local laws.

**KEEP THIS PACKAGING FOR REFERENCE AS IT CONTAINS IMPORTANT INFORMATION.**

## **BATTERY WARNING:**

- Do not mix old and new batteries.
  - Do not mix alkaline, standard (carbon-zinc), or rechargeable batteries.
  - Insert batteries using the correct polarity. Do not short-circuit the supply terminal.
  - Remove batteries when not in use. Recycle or dispose of exhausted batteries according to federal, state, and local laws. Do not dispose of batteries in a fire - they may leak or explode.
  - Only use manufacture specified battery(ies), charger(s) and/or adapter, if applicable, specified by the manufacturer.
  - Always use, replace, and recharge (if applicable) batteries under adult supervision.
- KEEP THIS PACKAGING FOR REFERENCE AS IT CONTAINS IMPORTANT INFORMATION.**

## Charging Battery

1. Turn off the drone before charging.
2. Take off the drone battery and connect the battery charger cable to the charging port on the battery
3. Connect USB connector to the power source.

Note: The Battery Charger will light up when it is charging the battery and turn off when the battery is fully charged.

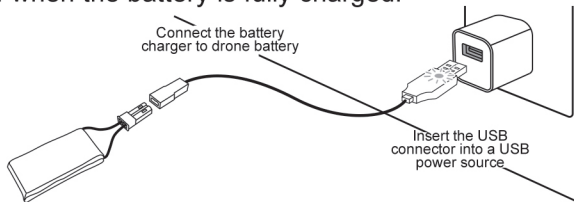

# BATTERY INSTALLATION

## How to install the battery

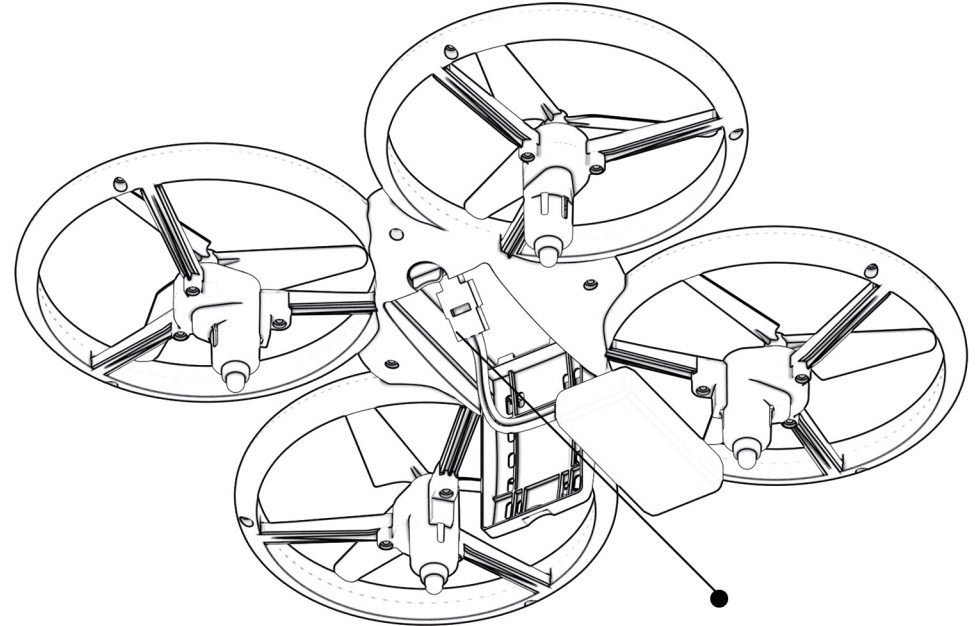

Open the battery compartment at the bottom, align the socket on the battery with the interface, and connect the battery, remember to insert it correct. Put the battery into the battery compartment and close battery cover, turn the knob tightly, and observe whether the battery compartment is tightly close.

## REPLACING PROPELLERS

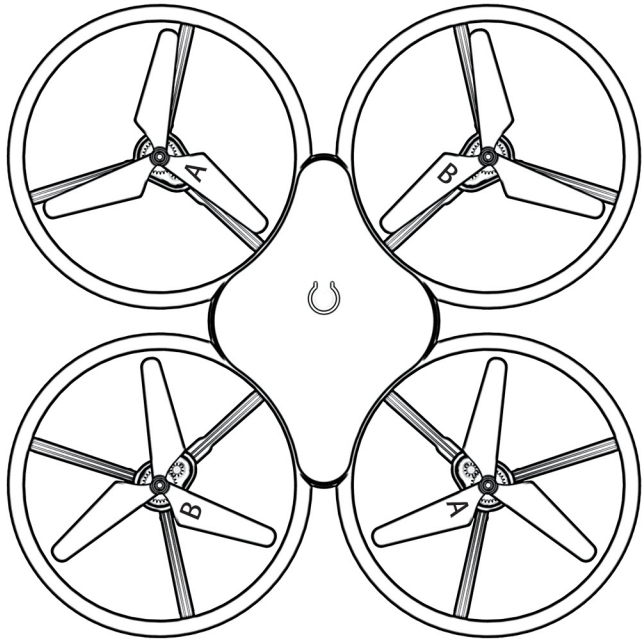

- Only an adult should replace blades. To remove, pull up the blades directly.
- Replace propellers by following the diagram.
- Each blade spins differently. Blade B spins counter clockwise and Blade A spins clockwise.

## REMOTE OVERVIEW

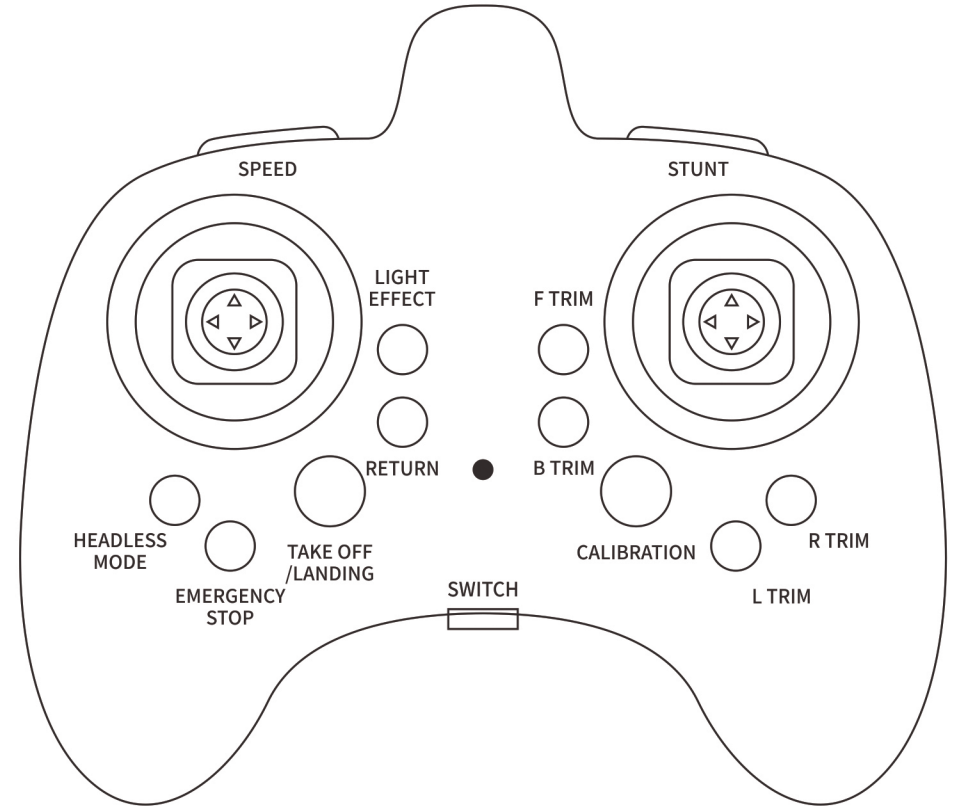

# OPERATING DRONE

## Step 1 - Pre-Flight Checklist.

1. Read all warnings and instructions.
2. Install remote batteries, page 16.
3. Charge batteries, page 15.
4. Make sure that the drone and remote are powered off.

## Step 2 - Choosing a location.

- Drone is designed to be flown indoors and outdoors.
- Always make sure you have enough space to fly drone.
- Always follow warnings, page 13.

## Step 3 - Pre - Flight

- Make sure your remote is off.
- Push the power button on top of the drone and hold on 1-2s until LED lights on.
- Place drone on a flat even surface. The blue lights should be toward you.
- Turn on the Remote controller. Push the left stick up and then down.
- The drone's lights will flicker during the pairing process and then remain on once it has paired.
- After pairing, push the left and right joysticks of the remote control in the inner eight directions at the same time to calibrate, and the lights of the drone will flash.

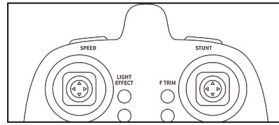
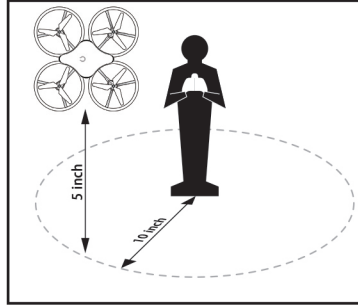

## Step 4 - Lift Off.

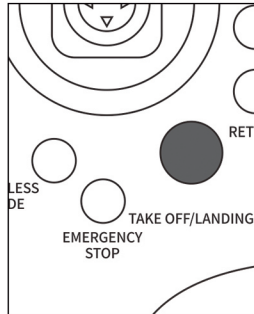

Press the Auto Take off Button.

OR

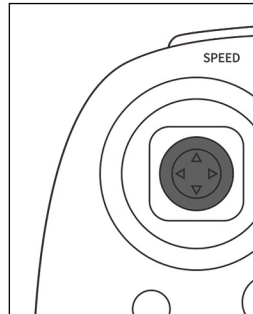

Slowly and carefully press the Throttle stick. Drone will begin to elevate.

# OPERATION

## Step 5 - Operating Drone in Flight.

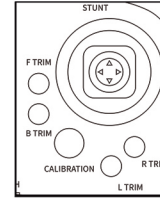

1. Follow this step if your drone begins to drift during take off or during flight.

A. Drone drifts backwards: Press the Forward Trim Button.

B. Drone drifts forwards: Press the Backwards Trim Button.

C. Drone drift right: Press the Left Trim Button.

D. Drone drift left: Press the Right Trim Button.

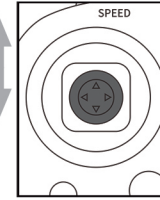

2. Use the Throttle Joystick to increase or decrease your elevation.

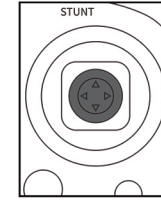

3. Use the Multi Directional Joystick to move forwards, backwards or side to side.

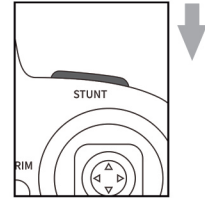

4. Stunts - Press the Stunt Button then press the Multi Directional Joystick in the direction you want to complete a stunt.

Note:  
1. The stunt function will be disabled if the drone battery power is low.  
2. Hover the drone at or above 10 feet before attempting a stunt.

## Step 6 - Landing Drone

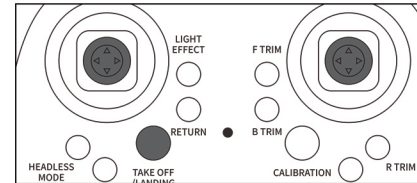

1. Lower drone to 20 feet or less then press the Auto Land button. Use the Multi Directional Joystick to maneuver drone. Or Push the left joystick down until the drone landing.

## Step 7 - Retrieving Drone

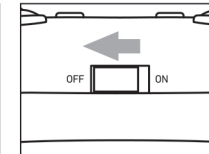

Turn off the drone and controller

# LIGHT SWITCHING FUNCTION

## light effect switch

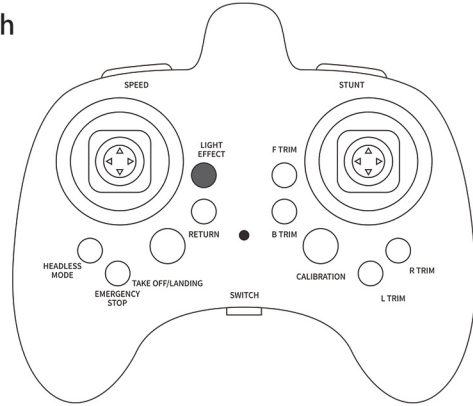

After frequency matching, you can enter the light switching mode. Press the light effect switching key to change various colorful lights;



# OTHER FUNTION

## Headless mode/one button return function

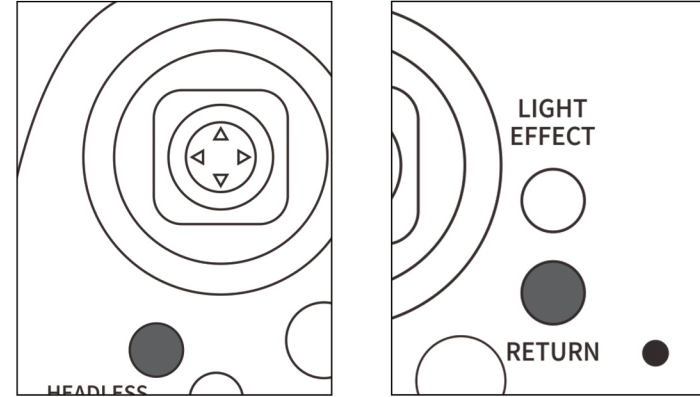

Press the Headless Mode button to turn mode on, and then press again to turn headless mode off.

- In this mode, the drone will always move in the direction in which you press the multidirectional key. No matter which direction the drone faces, it will be oriented to Users (remote control).
- When in headless mode, the remote control will beep every 6 seconds. Press the emergency stop button in case of emergency.

Automatic return function:  
If you want to make the aircraft fly back automatically, please first control the aircraft to the front of the operator, and press the one button return button, the aircraft will fly back automatically.

### Tips

- Do not bump the drone into sand or mud. drone gear may be blocked
- The first time you learn to fly, practice taking off and hovering.
- Keep a few feet away from walls and buildings.